



www.ktekcorp.com



MT5000

Guided Wave Radar Liquid Level Transmitter

FEATURES

- Graphic Display with Waveform Screen
- Widest Selection of Wetted Materials
- Radar Signal Travels Along the Waveguide – Eliminates False Echoes and Minimizes Signal Loss
- No Moving Parts
- Linearization Table
- Lengths from 1 to 200 ft. / 0.3 to 61 meters
- Rigid, Flexible Cable & Coaxial Probes
- All Digital Electronics



OPTIONS

- HART Protocol
- Glass Viewing Window
- 316L Stainless Steel Enclosure
- MODBUS
- Foundation Fieldbus

ACCESSORIES

- K-COM™ Communications Software
- External Chambers
- Stilling Wells
- Loop Indicators

SPECIFICATIONS

Housing	Dual Compartment Powder Coated Aluminum or Stainless Steel
Power	13.5 – 36 VDC, Standard; 9-32 VDC Foundation Fieldbus; 10 - 18 VDC MODBUS
Wiring	Standard and Foundation Fieldbus - 2 wire MODBUS - 4 wire plus shield (2 power, 2 data - half duplex)
Output	Single 4-20 mA, HART, Foundation Fieldbus (ITK 5.0.1), MODBUS (RTU or ASCII)
Graphic Display	Field Selectable Units in Feet, Inches, Millimeters, Centimeters, Meters or Percentage and Waveform Screens
Accuracy	+/- 0.1 in / 3mm for coaxial probes*, +/- 0.2 in / 5 mm for all other configurations
Resolution	+/- 0.063 in / 1.6 mm
Repeatability	0.1 in. / 3 mm *
Range	1 to 200 ft. / 0.3 to 61 meters
Process Connection	3/4" NPT Standard
Sensor Material	316L SS Standard, Other Materials Optional
Process Pressure	Up to 5000 psi (344 bar)
Process Temperature	Up to 800°F (427°C)
Dielectric Constant	Minimum 1.4
Process Max Vis	1500 cp
Approvals	 Factory Mutual Research Corporation

XP-IS / I / 1 / ABCD / T6 Ta = 77°C
 DIP / II, III / 1 / EFG / T6 Ta = 77°C
 IS / I / 1 / ABCD / T4 Ta = 77°C - ELE1034
 NI / I / 2 / ABCD / T4 Ta = 77°C
 S / II, III / 2 / FG / T4 Ta = 77°C
 ANI / I / 2 / ABCD / T4 - ELE1034
 Type 4X



Canadian Standards Association

XP CL 1, DIV 1, GP ABCD; CL 2, DIV 1, GP EFG; CL 3 - T6
 CL 1, DIV 2, GP ABCD; CL 2, DIV 2, GP EFG - T5
 IS CL 1, DIV 1, GP CD; CL 2, DIV 1, GP EFG - T4
 - when installed per ELE1034
 Type 4X

* based on non-changing dielectric constant. May require use of included Linearization Table



GOST - Russian

Flameproof: 1Exd[ja]IIBT6
 Intrinsically Safe: 0ExialIBT6
 Ingress Protection: IP67

ORDERING INFORMATION

MT5000 a/b/c/d/e/f/g/h/i/j/k

/a Probe Material

S6	316L Stainless Steel Standard
HC	Hastelloy C-276 (Rigid Probes Only, P43 probe HSC-270)
HB	Hastelloy B3 (Rigid Probes Only)
MO	Monel
TI	Titanium (Rigid Probes Only)

/b Transmitter Configuration

L	Local Transmitter Standard
LW	Local Transmitter with Window Cover Standard
R	Remote Mounted Electronics with 5 ft. Cable (Dielectric > 35)
RW	Remote Mounted Electronics with Window Cover and 5 ft. Cable (Dielectric > 35)

/c Transmitter Housing

A	Dual Compartment Aluminum Housing Standard
S	Dual Compartment 316L Stainless Steel Housing

/d Process Connection / Waveguide Coupler

Cxxonn	xx Process Connection & Waveguide Coupler (Table 1)
	o Seal Code (no code required for C8 or C9) (Table 2)
	nn Tri-clamp Size C6 & C7 Sanitary Couplers, NPT for C10 Coupler

/e Probe Type

X	None
Pxxoo	xx Probe Code (Table 3)
	oo Sanitary Probe Finish (P41, P42 and P43 Sanitary Probes Only)
	1F - 180 Grit
	2F - 240 Grit
	EP - 240 Grit and Electro-polish

/f Probe Attachment

X	None
CDyyz-ww	Clamp On Centering Disk (Solid Rod Probes) Note: Rigid probes installed in stilling wells or external chambers require centering disk
CWyyz-ww	Clamp On Centering Weight (Cable Probes) Note: Cable probes require a centering weight or end fitting to stabilize bottom of cable
E	Eyelet (Cable Probes)

/g Process Temperature

H0	32 to 250°F / 0 to 121°C
H6	C1 thru C7 and C10 couplers: Above 250°F / 121°C or below 32°F / 0°C Electronics enclosure is extended 6" above process connection C8 and C9 couplers: Above 500°F / 260°C Extends electronics enclosure an additional 6" above process connection (Refer to Table 1 for maximum and minimum process temperatures)

/h Electronic Module

X	None
M7A	One Level, Graphic Display , 4-20 mA Output, HART Add suffix "M" for MODBUS (not Intrinsically Safe) Add suffix "F" for Foundation Fieldbus



/i Select the Approval

- X None
- FM Factory Mutual Research Corporation and Canadian Standards Association
- GR GOST - Russian
(M7AM option not Intrinsically Safe)

/j Process Connection

- P Standard as shown on Probe Process Connection Table (**Table 1**)
- FL Loose flange or plug for use with probe NPT threads; Specify type, material and rating from Flange Designation Chart (SLG-0001-1)
- WP Welded process connection Specify type, material and rating from Flange Designation Chart (SLG-0001-1)
The Flange Designation Guide is available under Data Sheets on the MT5000 Product Page on K-TEK's Website (www.ktekcorp.com)
Welded Flanges 400# and above may require the use of an H6 extension.

/k Length

- L Insertion length from face of coupler in inches or millimeters.
 - 12in / 305mm minimum
 - maximum based on probe type

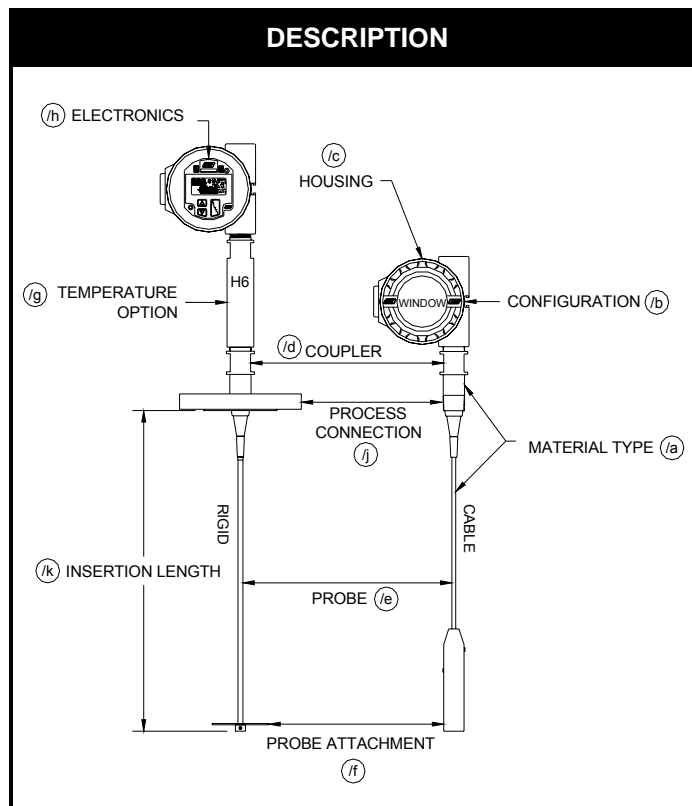

Table 1 - PROCESS CONNECTION / WAVEGUIDE COUPLER

Base Code ⁴	Insulator	Process Connection	Seal Options Table 2	Maximum Pressure	Min Temp ⁶	Max Temp ⁶	Compatible Probes
SINGLE PROBE / COAXIAL PROBE							
C1o^{1,2}	Teflon	3/4" NPT ⁸	V, K E, A	1500 psi @ 100°F / 103 bar @ 38°C 600 psi @ 400°F / 41 bar @ 204°C	-60°F -50°C	400°F 204°C	P01, P03, P11, P51, P91 ⁸
C2o^{1,2}		1.5" NPT					
C8 (316SS only)	Borosilicate Glass	1.5" NPT	Hermetic	5000 psi @ 100°F / 344 bar @ 38°C 1500 psi @ 800°F / 103 bar @ 427°C Not for Hot Water or Steam Service	-60°F -50°C	800°F 427°C	P11 ⁵ , P71 (316SS only)
C9 (316SS only)	Alumina Ceramic	1" NPT	Aegis	2000 psi @ 635°F / 138 bar @ 335°C	-60°F -50°C	635°F 335°C	P11 ⁵ , P81 (316SS only)
DUAL PROBE							
C4o^{1,2}	Teflon	1.5" NPT	V, K E, A	1500 psi @ 100°F / 103 bar @ 38°C 600 psi @ 400°F / 41 bar @ 204°C	-60°F -50°C	400°F 204°C	P31
C5o^{1,2}		2" NPT					P22, P32
TRI-TAPE PROBE							
C10on^{1,2,7}	Teflon	2" or 3" NPT	V, K E, A	1500 psi @ 100°F / 103 bar @ 38°C 600 psi @ 400°F / 41 bar @ 204°C	-60°F -50°C	400°F 204°C	P34 (316SS only)
SANITARY PROBE							
C6onn^{2,3}	Teflon	1.5" or larger Tri-Clamp	V, K E, A	50 psi / 13.4 bar	-60°F -50°C	400°F 204°C	P41, P43
C7onn^{2,3}		2.5" or larger Tri-Clamp					P42, P43
CUSTOM							
CXo	Custom (Consult Factory)						
Notes:	<ol style="list-style-type: none"> Add the suffix "H" to the Base Code (example: /C1HV) to increase the maximum pressure to: 3000 psi @ 100 F / 207 bar @ 38 C 1200 psi @ 400 F / 83 bar @ 204 C Add the suffix "S" to the Base Code to include a hermetic seal (example: /C4SV) Tri-Clamp size "nn" as follows: 1.5" = 15, 2" = 20, 2.5" = 25, 3.0" = 30 (example: /C6V20) o - Enter seal code from table 2 (example /C2V. Not required for /C8) Requires installation in a stilling well or external chamber Consult Table 2 for o-ring temperature specifications. Thread size "n" as follows: 2" NPT = 2, 3" NPT = 3 (example: /C10V3) The P91 probe has a 1" MNPT adjustable compression fitting equipped with Teflon ferrules as the standard process connection. The maximum process pressure utilizing the Teflon ferrules is 50 psi (3.4 bars). 						

Table 2 - O-RING SEALS

Suffix	Description	Min. Temp	Max. Temp	Compatible With	Not Compatible With
V	Viton	-15°F -26°C	400°F 204°C	General Purpose, Ethylene	Ketones (MEK, Acetone), Skydrol Fluids, Amines, Anhydrous Ammonia, Low Molecular Weight Esters and Ethers, Hot Hydrofluoric or Chlorosulfuric Acids, Sour HCs
K	Kalrez	-40°F -40°C	400°F 204°C	Inorganic and Organic Acids to Include HH and Nitric, Aldehydes, Ethylene, Glycols, Organic Oils, Silicone Oils, Vinegar, Sour HCs, Amines, Ethylene Oxide, Propylene Oxide	Black Liquor, Hot Water, Hot Aliphatic Amines, Molten Sodium, Molten Potassium
E	EPDM	-60°F -50°C	250°F 125°C	Acetone, MEK, Skydrol Fluids, Anhydrous Ammonia	Petroleum Oils, Di-Ester Base Lubricants, Propane
A	Aegis	-14°F -10°C	572°F 300°C	Most Chemicals	Brake Fluid

Table 3 - PROBE TYPES				
Code	O.D	Notes	Max Length	Attachment Options
SINGLE RIGID ROD				
P01	0.25in (6mm)		10ft (3.05m) ¹	CD
P02	0.50in (13mm)		20ft (6.10m) ²	
P03	0.375in (9mm)		10ft (3.05m) ¹	
SINGLE FLEXIBLE CABLE				
P11	0.1875in (5mm)		100ft (30.5m) ³	CD, CW, E
P12	0.25in (6mm)			
DUAL RIGID ROD				
P22	0.50in (13mm)		30ft (9.14m)	CD
DUAL FLEXIBLE CABLE				
P31	0.1875in (5mm)		100ft (30.5m)	CW
P32	0.25in (6mm)			
TRI-TAPE				
P34	2.00in (51mm)	316SS only	50ft (15.24m)	CW (included)
SANITARY RIGID ROD				
P41	0.25in (6mm)	Finish Options: 1F - 180 Grit Finish (std) 2F - 240 Grit Finish EP - 240 Grit and Electro polished ⁴	10ft (3.05m)	CD (custom)
P42	0.50in (13mm)		20ft (6.10m)	
P43	0.125in (3mm)	316 SS and HSC-270	50ft (15.24m)	CW (included)
COAXIAL (clean liquids only)				
P51	0.875in (22mm)		22ft (6.71m)	
P71	1.315in (34mm)	316SS only		
P81	0.875in (22mm)	316SS only		
P91	1.00in (25mm)			
CUSTOM				
/PXX	Custom Probe, Consult Factory			
Notes:	<ol style="list-style-type: none"> 1. 5ft (1.52m) maximum probe length when installed in a stilling well or EC chamber (minimum 2" diameter) 2. 10ft (3.05m) maximum probe length when installed in a stilling well or EC chamber (minimum 3" diameter) 3. Lengths greater than 7ft (2.13m) require cable spacers at 5ft (1.52m) maximum intervals when installed in a 2" or smaller stilling well or EC chamber. Lengths greater than 10ft (3.05m) require cable spacers at 10ft (3.05m) maximum intervals when installed in 2.5" - 3" stilling well or EC chamber. 4. Certificate of RA and Passivation available upon request. Specify RA finish. 			

MT5000 Recommended Installation

NOTE: The following guidelines are very conservative. If you have an application that exceeds these limits consult factory for application recommendations.

1. SINGLE PROBE - FLAT PLATE

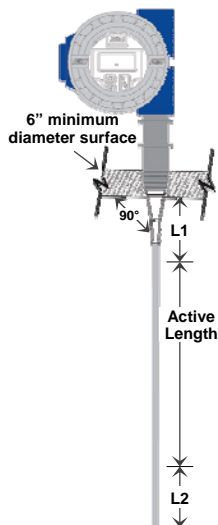

MINIMUM DIELECTRIC CONSTANT	L MAXIMUM PROBE LENGTH ²	L1 Unmeasurable ¹	L2 Unmeasurable ¹ (WH = Weight Height)
4	20 ft. / 6.1 m	6 in. / 15.2 cm	3 in. / 7.6 cm (Rod) WH + 3 in. / 7.6 cm (cable)
10	40 ft. / 12.2 m	3 in. / 7.5 cm	0 ¹ (Rod) WH + 3" / 7.6 cm (cable)
35	100 ft. / 30.5 m	0 ¹ in. / 0 ¹ cm	0 ¹ (Rod / Cable)

NOTES:

- L1 & L2 unmeasurable lengths of 0 may require use of linearization table and latching feature. For easiest startup use $L1_{min} \geq 3"$ or as listed if greater and $L2_{min} \geq 3"$ (rod) or $WH + 3"$ (cable).
- Maximum probe lengths are limited as indicated in Table 2A.

2. SINGLE PROBE - FLAT PLATE WITH COUPLING

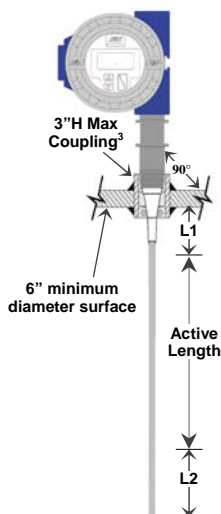

MINIMUM DIELECTRIC CONSTANT	L MAXIMUM PROBE LENGTH ²	L1 Unmeasurable ¹	L2 Unmeasurable ¹ (WH = Weight Height)
4	20 ft. / 6.1 m	8 in. / 20.3 cm	3 in. / 7.6 cm (Rod) WH + 3 in. / 7.5 cm (Cable)
10	40 ft. / 12.2 m	4 in. / 10.2 cm	0 ¹ (Rod) WH + 3 in. / 7.5 cm (Cable)
35	100 ft. / 30.5 m	1 in. / 2.5 cm	0 ¹ (Rod / Cable)

NOTES:

- L1 & L2 unmeasurable lengths of 0 may require use of linearization table and latching feature. For easiest startup use $L1_{min} \geq 3"$ or as listed if greater and $L2_{min} \geq 3"$ (rod) or $WH + 3"$ (cable).
- Maximum probe lengths are limited as indicated in Table 2A.
- The coupling should not extend into the vessel more than 1 in. / 2.5 cm.

3A. SINGLE PROBE - NOZZLE & FLANGE

[height of nozzle (H) greater than width of nozzle (S)]

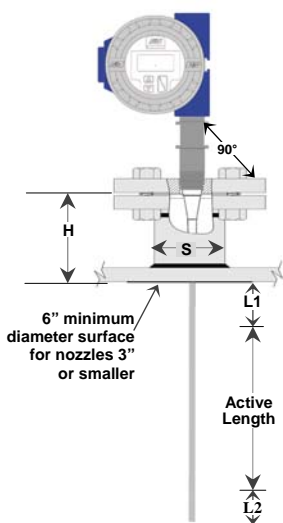

MINIMUM DIELECTRIC CONSTANT	L MAXIMUM PROBE LENGTH ²	L1 Unmeasurable ¹	L2 Unmeasurable ¹ (WH = Weight Height)
4	20 ft. / 6.1 m	8 in. / 20.3 cm	3 in. / 7.6 cm (Rod) WH + 3 in. / 7.5 cm (Cable)
10	40 ft. / 12.2 m	4 in. / 10.2 cm	0 ¹ (Rod) WH + 3 in. / 7.5 cm (Cable)
35	100 ft. / 30.5 m	2 ¹ in. / 5.1 ¹ cm	0 ¹ (Rod / Cable)

NOTES:

- L1 & L2 unmeasurable lengths of 0 may require use of linearization table and latching feature. For easiest startup use $L1_{min} \geq 3"$ or as listed if greater and $L2_{min} \geq 3"$ (rod) or $WH + 3"$ (cable).
- Maximum probe lengths are limited as indicated in Table 2A.
- A one time startup adjustment is required to eliminate the effect of the nozzle. For details refer to the Blanking Parameter in the Commissioning section of the Installation & Operation Manual.

MT5000 Recommended Installation

NOTE: The following guidelines are very conservative. If you have an application that exceeds these limits consult factory for application recommendations.

3B. SINGLE PROBE - NOZZLE & FLANGE

[height of nozzle (H) less than width of nozzle (S)]

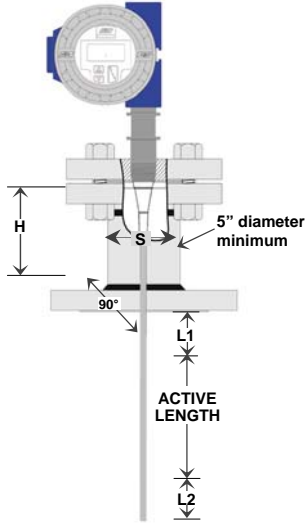

MINIMUM DIELECTRIC CONSTANT	L MAXIMUM PROBE LENGTH ²	L1 Unmeasurable ¹	L2 Unmeasurable ¹ (WH = Weight Height)
4	20 ft. / 6.1 m	6 in. / 15.24 cm	3 in. / 7.6 cm (Rod) WH + 3 in. / 7.6 cm (Cable)
10	40 ft. / 12.2 m	3 in. / 7.5 cm	0 ¹ (Rod) WH + 3 in. / 7.6 cm (Cable)
35	100 ft. / 30.5 m	2 ¹ in. / 5.1 ¹ cm	0 ¹ (Rod / Cable)

NOTES:

- L1 & L2 unmeasurable lengths of 0 may require use of linearization table and latching feature. For easiest startup use $L1_{min} \geq 3"$ or as listed if greater and $L2_{min} \geq 3"$ (rod) or $WH + 3"$ (cable).
- Maximum probe lengths are limited as indicated in Table 2A.
- A one time startup adjustment is required to eliminate the effect of the nozzle. For details refer to the Blanking Parameter in the Commissioning section of the Installation & Operation Manual.

4. SINGLE PROBE - PERMANENT STILLING WELL

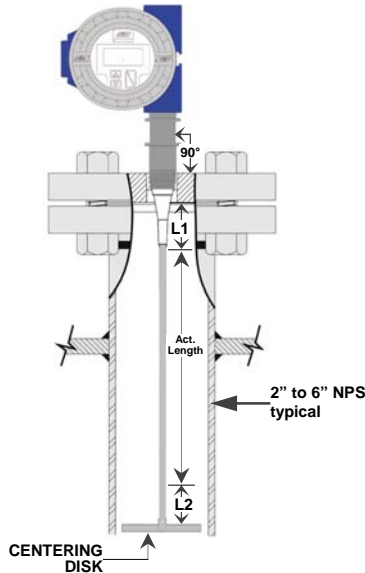

MINIMUM DIELECTRIC CONSTANT	L MAXIMUM PROBE LENGTH ²	L1 Unmeasurable ¹	L2 Unmeasurable ¹ (WH = Weight Height)
1.7 ³	20 ft. / 6.1 m	8 in. / 20.3 cm	3 in. / 7.6 cm (Rod) WH + 3 in. / 7.6 cm (Cable)
3	30 ft. / 9.1 m	6 in. / 15.2 cm	3 in. / 7.6 cm (Rod) WH + 3 in. / 7.6 cm (Cable)
10	50 ft. / 15.2 m	3 in. / 7.5 cm	0 ¹ (Rod) WH + 3 in. / 7.6 cm (Cable)
35	50 ft. / 15.2 m	0 ¹ in. / 0 ¹ cm	0 ¹ (Rod / Cable)

NOTES:

- L1 & L2 unmeasurable lengths of 0 may require use of linearization table and latching feature. For easiest startup use $L1_{min} \geq 3"$ or as listed if greater and $L2_{min} \geq 3"$ (rod) or $WH + 3"$ (cable).
- Maximum probe lengths are limited as indicated in Table 2A.
- Stilling well size will determine minimum dielectric constant.

5. SINGLE PROBE - REMOVABLE STILLING WELL & TRI-TAPE

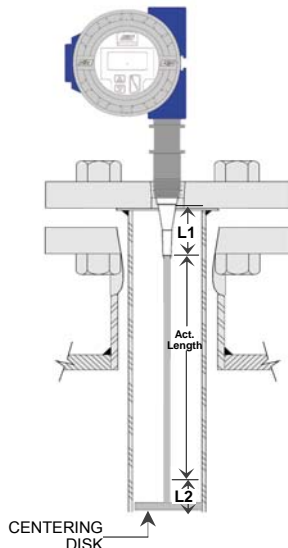

MINIMUM DIELECTRIC CONSTANT	L MAXIMUM PROBE LENGTH ²	L1 Unmeasurable ¹	L2 Unmeasurable ¹ (WH = Weight Height)
1.7 ³	20 ft. / 6.1 m	8 in. / 20.3 cm	3 in. / 7.6 cm (Rod) WH + 3 in. / 7.6 cm (Cable)
3	30 ft. / 9.1 m	6 in. / 15.2 cm	3 in. / 7.6 cm (Rod) WH + 3 in. / 7.6 cm (Cable)
10	50 ft. / 15.2 m	3 in. / 7.5 cm	0 ¹ (Rod) WH + 3 in. / 7.6 cm (Cable)
35	50 ft. / 15.2 m	0 ¹ in. / 0 ¹ cm	0 ¹ (Rod / Cable)

NOTES:

- L1 & L2 unmeasurable lengths of 0 may require use of linearization table and latching feature. For easiest startup use $L1_{min} \geq 3"$ or as listed if greater and $L2_{min} \geq 3"$ (rod) or $WH + 3"$ (cable).
- Maximum probe lengths are limited as indicated in Table 2A.
- Stilling well size will determine minimum dielectric constant.

MT5000 Recommended Installation

NOTE: The following guidelines are very conservative. If you have an application that exceeds these limits consult factory for application recommendations.

6. SINGLE PROBE - EXTERNAL CHAMBER

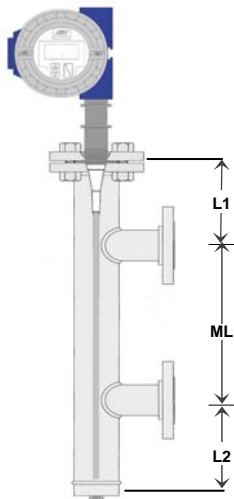

MINIMUM DIELECTRIC CONSTANT	L MAXIMUM PROBE LENGTH ²	L1 Unmeasurable ¹	L2 Unmeasurable ¹ (WH = Weight Height)
1.7 ³	20 ft. / 6.1 m	8 in. / 20.3 cm	3 in. / 7.6 cm (Rod) WH + 3 in. / 7.6 cm (Cable)
3	30 ft. / 9.1 m	6 in. / 15.2 cm	3 in. / 7.6 cm (Rod) WH + 3 in. / 7.6 cm (Cable)
10	50 ft. / 15.2 m	3 in. / 7.5 cm	0 ¹ (Rod) WH + 3 in. / 7.6 cm (Cable)
35	50 ft. / 15.2 m	0 ¹ in. / 0 ¹ cm	0 ¹ (Rod / Cable)

NOTES:

- L1 & L2 unmeasurable lengths of 0 may require use of linearization table and latching feature. For easiest startup use $L1_{min} \geq 3''$ or as listed if greater and $L2_{min} \geq 3''$ (rod) or $WH + 3''$ (cable).
- Maximum probe lengths are limited as indicated in Table 2A.
- Chamber size will determine minimum dielectric constant.

7. COAXIAL PROBE

[(rod inside of outer tube) clean liquids only]

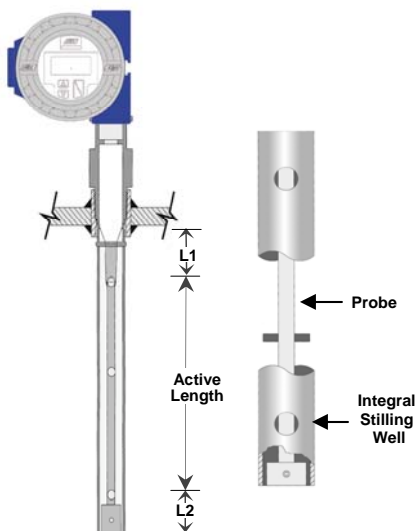

MINIMUM DIELECTRIC CONSTANT	L MAXIMUM PROBE LENGTH ²	L1 Unmeasurable ¹	L2 Unmeasurable ¹
1.4	20 ft. / 6.1 m	4 in. / 10.2 cm	1 in. / 2.5 cm
2.0	20 ft. / 6.1 m	2 in. / 5.1 cm	1 in. / 2.5 cm
4.0	20 ft. / 6.1 m	0 in. / 0 cm	0.5 in. / 1.3 cm

NOTES:

- L1 & L2 unmeasurable lengths of 0 may require use of linearization table and latching feature. For easiest startup use $L1_{min} \geq 3''$ or as listed if greater and $L2_{min} \geq 3''$ (rod) or $WH + 3''$ (cable).
- Maximum probe lengths are limited as indicated in Table 2A.
- Typically used in low dielectric, clean liquids.

8. DUAL PROBE - FLAT PLATE

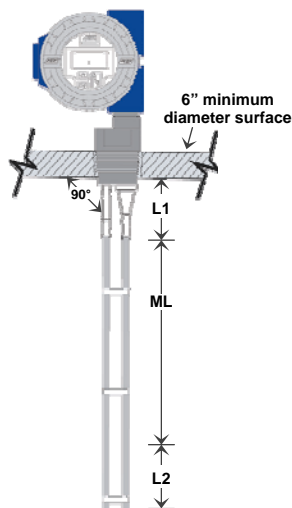

MINIMUM DIELECTRIC CONSTANT	L MAXIMUM PROBE LENGTH ²	L1 Unmeasurable ¹	L2 Unmeasurable ¹ (WH = Weight Height)
3	20 ft. / 6.1 m	6 in. / 15.2 cm	3 in. / 7.6 cm (Rod) WH + 3 in. / 7.6 cm (Cable)
4	20 ft. / 6.1 m	3 in. / 7.5 cm	3 in. / 7.6 cm (Rod) WH + 3 in. / 7.6 cm (Cable)
10	100 ft. / 30.5 m	0 ¹ in. / 0 ¹ cm	0 ¹ (Rod / Cable)

NOTES:

- L1 & L2 unmeasurable lengths of 0 may require use of linearization table and latching feature. For easiest startup use $L1_{min} \geq 3''$ or as listed if greater and $L2_{min} \geq 3''$ (rod) or $WH + 3''$ (cable).
- Maximum probe lengths are limited as indicated in Table 2A.

MT5000 Recommended Installation

NOTE: The following guidelines are very conservative. If you have an application that exceeds these limits consult factory for application recommendations.

9. DUAL PROBE - FLAT PLATE WITH COUPLING

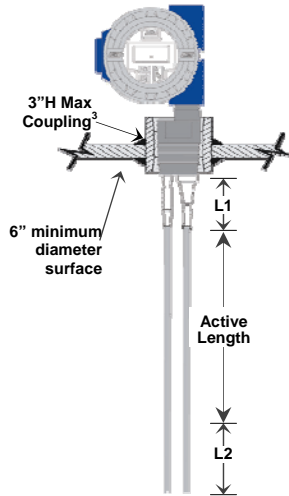

MINIMUM DIELECTRIC CONSTANT	L MAXIMUM PROBE LENGTH ²	L1 Unmeasurable ¹	L2 Unmeasurable ¹
3	20 ft. / 6.1 m	6 in. / 15.2 cm	3 in. / 7.6 cm (Rod) WH + 3 in. / 7.6 cm (Cable)
4	20 ft. / 6.1 m	3 in. / 7.5 cm	3 in. / 7.6 cm (Rod) WH + 3 in. / 7.6 cm (Cable)
10	100 ft. / 30.5 m	0 ¹ in. / 0 ¹ cm	0 ¹ (Rod / Cable)

NOTES:

1. L1 & L2 unmeasurable lengths of 0 may require use of linearization table and latching feature. For easiest startup use $L1_{min} \geq 3"$ or as listed if greater and $L2_{min} \geq 3"$ (rod) or $WH + 3"$ (cable).
2. Maximum probe lengths are limited as indicated in Table 2A.
3. The coupling should not extend into the vessel more than 1" / 25 mm.

10A. DUAL PROBE - NOZZLE & FLANGE

[height of nozzle (H) greater than width of nozzle (S)]

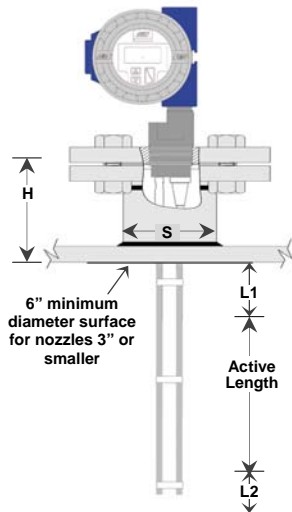

MINIMUM DIELECTRIC CONSTANT	L MAXIMUM PROBE LENGTH ²	L1 Unmeasurable ¹	L2 Unmeasurable ¹
3	20 ft. / 6.1 m	6 in. / 15.2 cm	3 in. / 7.6 cm (Rod) WH + 3 in. / 7.6 cm (Cable)
4	20 ft. / 6.1 m	3 in. / 7.5 cm	3 in. / 7.6 cm (Rod) WH + 3 in. / 7.6 cm (Cable)
10	100 ft. / 30.5 m	0 ¹ in. / 0 ¹ cm	0 ¹ (Rod / Cable)

NOTES:

1. L1 & L2 unmeasurable lengths of 0 may require use of linearization table and latching feature. For easiest startup use $L1_{min} \geq 3"$ or as listed if greater and $L2_{min} \geq 3"$ (rod) or $WH + 3"$ (cable).
2. Maximum probe lengths are limited as indicated in Table 2A.
3. A one time startup adjustment is required to eliminate the effect of the nozzle. For details refer to the Blanking Parameter in the Commissioning section of the Installation & Operation Manual.

10B. DUAL PROBE - NOZZLE & FLANGE

[height of nozzle (H) less than width of nozzle (S)]

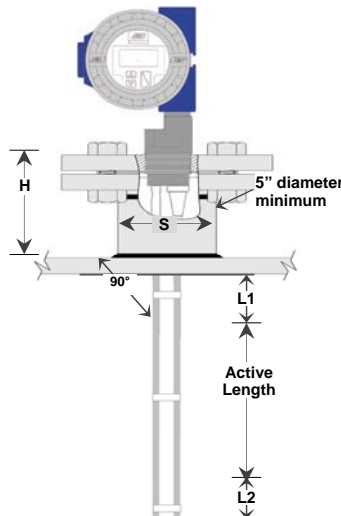

MINIMUM DIELECTRIC CONSTANT	L MAXIMUM PROBE LENGTH ²	L1 Unmeasurable ¹	L2 Unmeasurable ¹
3	20 ft. / 6.1 m	6 in. / 15.2 cm	3 in. / 7.6 cm (Rod) WH + 3 in. / 7.6 cm (Cable)
4	20 ft. / 6.1 m	3 in. / 7.5 cm	3 in. / 7.6 cm (Rod) WH + 3 in. / 7.6 cm (Cable)
10	100 ft. / 30.5 m	0 ¹ in. / 0 ¹ cm	0 ¹ (Rod / Cable)

NOTES:

1. L1 & L2 unmeasurable lengths of 0 may require use of linearization table and latching feature. For easiest startup use $L1_{min} \geq 3"$ or as listed if greater and $L2_{min} \geq 3"$ (rod) or $WH + 3"$ (cable).
2. Maximum probe lengths are limited as indicated in Table 2A.

MT5000 Guided Wave Radar Probe Attachments

Cable Weights					
Part No.	Material	O.D.	Weight Height (WH)	Weight	Compatible Probes
CW09D-S6	316SS	0.875 in. / 22.2 mm	4.0 in. / 101.6 mm	0.7 lbs / 301 g	P11
CW09D-MO	Monel			0.8 lbs / 324 g	
CW10D-S6	316SS	1.0 in. / 25.4 mm	6.0 in. / 152.4 mm	1.3 lbs / 590 g	P11
CW10D-MO	Monel			1.4 lbs / 635 g	
CW10E-S6	316SS			1.3 lbs / 590 g	P12
CW10E-MO	Monel			1.4 lbs / 635 g	
CW16F-S6	316SS	1.625 in. / 41.3 mm	2.0 in. / 50.8 mm	1.1 lbs / 499 g	P11, P31
CW16F-MO	Monel			1.2 lbs / 544 g	
CW19G-S6	316SS	1.875 in. / 47.6 mm	2.0 in. / 50.8 mm	1.5 lbs / 680 g	P12, P32
CW19G-MO	Monel			1.6 lbs / 726 g	
CW29F-S6	316SS	2.875 in. / 73.3 mm	1.0 in. / 25.4 mm	1.8 lbs / 816 g	P11, P31
CW29F-MO	Monel			2.0 lbs / 907 g	
CW29G-S6	316SS			1.8 lbs / 816 g	P12, P32
CW29G-MO	Monel			2.0 lbs / 907 g	

For included weights on /P34 and /P43 probes use code /CW-S6

Centering Disks				
Part No.	O.D.	Height	Compatible Probes	Minimum Stilling Well Size
CD15B-%	1.5 in / 38.1 mm	0.375 in / 9.5 mm	P01	1.5 in sch. 40
CD15C-%		0.5 in / 12.7 mm	P02	
CD15I-%		0.4375 in / 11 mm	P03	
CD20B-%	2.0 in. / 50.8 mm	0.375 in / 9.5 mm	P01	2 in sch. 40
CD20C-%		0.5 in / 12.7 mm	P02	
CD20I-%		0.4375 in / 11 mm	P03	
CD23B-%	2.3 in. / 58.7 mm	0.375 in / 9.5 mm	P01	2.5 in sch. 40
CD23C-%		0.5 in / 12.7 mm	P02	
CD23I-%		0.4375 in / 11 mm	P03	
CD28B-%	2.8 in. / 71.1 mm	0.375 in / 9.5 mm	P01	3 in sch. 80
CD28C-%		0.5 in / 12.7 mm	P02	
CD28I-%		0.4375 in / 11 mm	P03	
CD38B-%	3.75 in. / 95.3 mm	0.375 in / 9.5 mm	P01	4 in sch. 80
CD38C-%		0.5 in / 12.7 mm	P02	
CD38I-%		0.4375 in / 11 mm	P03	

% - enter material code from /a

Quotation Request - MT5000 SERIES Guided Wave Radar

Tel (1) 225-673-6100 Email:sales@ktekcorp.com Date: _____

Fax (1) 225-673-2525 Attn: _____

Customer: _____
 Phone #: _____
 Email: _____
 Rep Firm: _____
 Phone #: _____
 Email: _____

Contact: _____
 Fax #: _____
 Project: _____
 Contact: _____
 Fax #: _____

Process Conditions: TAG: _____

Material To Be Measured: _____ Dielectric Constant: _____

Is Material: Solid Liquid Liquid/Liquid Interface (Refer to MT5100 Level and Interface Level Measurement Data Sheet (MT5100-0202-1) for more information.)

If Solid: Particle Diameter: _____ Bulk Density _____ **pcf / kg/m³**

If Liquid / Liquid Interface: Upper Dielectric Constant: _____ Lower Dielectric Constant: _____

Flooded Sensor Non-flooded Sensor

Temperature: Operating: _____ Maximum: _____ °F / °C / °K



Pressure: Operating: _____ Maximum: _____ PSIG / KG / BAR

Agitation: None Minimal Heavy

Foam: No Yes: Foam Density: Light Heavy

Buildup: None Light Heavy (Single Probe designs recommended with heavy buildup)

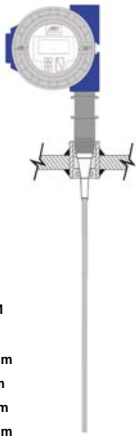
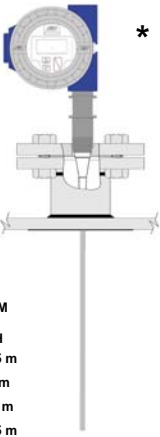
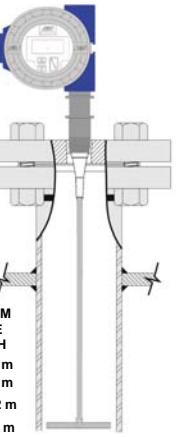
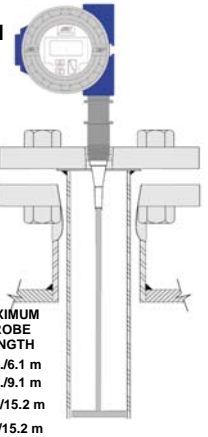
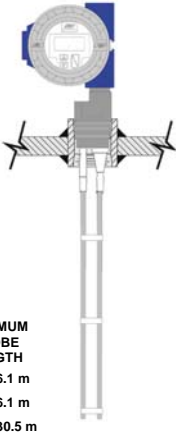
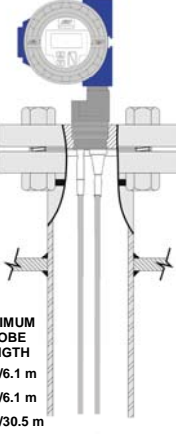
Select mounting configuration closest to your application: (*Not for liquid / liquid interface)

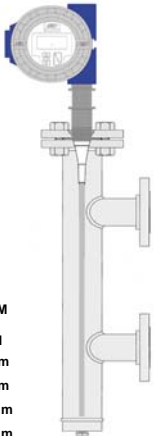
<p>Flat Plate Or Coupling</p>  <p>* </p> <table border="1"> <thead> <tr> <th>MINIMUM DIELECTRIC CONSTANT</th> <th>MAXIMUM PROBE LENGTH</th> </tr> </thead> <tbody> <tr> <td>1.3'</td> <td>100 ft./30.5 m</td> </tr> <tr> <td>4</td> <td>20 ft./6.1 m</td> </tr> <tr> <td>10</td> <td>40 ft./12.2 m</td> </tr> <tr> <td>35</td> <td>100 ft./30.5 m</td> </tr> </tbody> </table>	MINIMUM DIELECTRIC CONSTANT	MAXIMUM PROBE LENGTH	1.3'	100 ft./30.5 m	4	20 ft./6.1 m	10	40 ft./12.2 m	35	100 ft./30.5 m	<p>Nozzle & Flange</p>  <p>* </p> <table border="1"> <thead> <tr> <th>MINIMUM DIELECTRIC CONSTANT</th> <th>MAXIMUM PROBE LENGTH</th> </tr> </thead> <tbody> <tr> <td>1.3'</td> <td>100 ft./30.5 m</td> </tr> <tr> <td>4</td> <td>20 ft./6.1 m</td> </tr> <tr> <td>10</td> <td>40 ft./12.2 m</td> </tr> <tr> <td>35</td> <td>100 ft./30.5 m</td> </tr> </tbody> </table>	MINIMUM DIELECTRIC CONSTANT	MAXIMUM PROBE LENGTH	1.3'	100 ft./30.5 m	4	20 ft./6.1 m	10	40 ft./12.2 m	35	100 ft./30.5 m	<p>Permanent Stilling Well</p>  <table border="1"> <thead> <tr> <th>MINIMUM DIELECTRIC CONSTANT</th> <th>MAXIMUM PROBE LENGTH</th> </tr> </thead> <tbody> <tr> <td>1.7</td> <td>20 ft./6.1 m</td> </tr> <tr> <td>3</td> <td>30 ft./9.1 m</td> </tr> <tr> <td>10</td> <td>50 ft./15.2 m</td> </tr> <tr> <td>35</td> <td>50 ft./15.2 m</td> </tr> </tbody> </table>	MINIMUM DIELECTRIC CONSTANT	MAXIMUM PROBE LENGTH	1.7	20 ft./6.1 m	3	30 ft./9.1 m	10	50 ft./15.2 m	35	50 ft./15.2 m	<p>Removable Stilling Well</p>  <table border="1"> <thead> <tr> <th>MINIMUM DIELECTRIC CONSTANT</th> <th>MAXIMUM PROBE LENGTH</th> </tr> </thead> <tbody> <tr> <td>1.7</td> <td>20 ft./6.1 m</td> </tr> <tr> <td>3</td> <td>30 ft./9.1 m</td> </tr> <tr> <td>10</td> <td>50 ft./15.2 m</td> </tr> <tr> <td>35</td> <td>50 ft./15.2 m</td> </tr> </tbody> </table>	MINIMUM DIELECTRIC CONSTANT	MAXIMUM PROBE LENGTH	1.7	20 ft./6.1 m	3	30 ft./9.1 m	10	50 ft./15.2 m	35	50 ft./15.2 m
MINIMUM DIELECTRIC CONSTANT	MAXIMUM PROBE LENGTH																																										
1.3'	100 ft./30.5 m																																										
4	20 ft./6.1 m																																										
10	40 ft./12.2 m																																										
35	100 ft./30.5 m																																										
MINIMUM DIELECTRIC CONSTANT	MAXIMUM PROBE LENGTH																																										
1.3'	100 ft./30.5 m																																										
4	20 ft./6.1 m																																										
10	40 ft./12.2 m																																										
35	100 ft./30.5 m																																										
MINIMUM DIELECTRIC CONSTANT	MAXIMUM PROBE LENGTH																																										
1.7	20 ft./6.1 m																																										
3	30 ft./9.1 m																																										
10	50 ft./15.2 m																																										
35	50 ft./15.2 m																																										
MINIMUM DIELECTRIC CONSTANT	MAXIMUM PROBE LENGTH																																										
1.7	20 ft./6.1 m																																										
3	30 ft./9.1 m																																										
10	50 ft./15.2 m																																										
35	50 ft./15.2 m																																										
<p>Dual Rod Flat Plate or Coupling</p>  <table border="1"> <thead> <tr> <th>MINIMUM DIELECTRIC CONSTANT</th> <th>MAXIMUM PROBE LENGTH</th> </tr> </thead> <tbody> <tr> <td>3</td> <td>20 ft./6.1 m</td> </tr> <tr> <td>4</td> <td>20 ft./6.1 m</td> </tr> <tr> <td>10</td> <td>100 ft./30.5 m</td> </tr> </tbody> </table>	MINIMUM DIELECTRIC CONSTANT	MAXIMUM PROBE LENGTH	3	20 ft./6.1 m	4	20 ft./6.1 m	10	100 ft./30.5 m	<p>Dual Rod Nozzle & Flange</p>  <table border="1"> <thead> <tr> <th>MINIMUM DIELECTRIC CONSTANT</th> <th>MAXIMUM PROBE LENGTH</th> </tr> </thead> <tbody> <tr> <td>2.5</td> <td>20 ft./6.1 m</td> </tr> <tr> <td>4</td> <td>20 ft./6.1 m</td> </tr> <tr> <td>10</td> <td>100 ft./30.5 m</td> </tr> </tbody> </table>	MINIMUM DIELECTRIC CONSTANT	MAXIMUM PROBE LENGTH	2.5	20 ft./6.1 m	4	20 ft./6.1 m	10	100 ft./30.5 m	<p>Coaxial Probe</p>  <table border="1"> <thead> <tr> <th>MINIMUM DIELECTRIC CONSTANT</th> <th>MAXIMUM PROBE LENGTH</th> </tr> </thead> <tbody> <tr> <td>1.4</td> <td>20 ft./6.1 m</td> </tr> <tr> <td>4</td> <td>20 ft./6.1 m</td> </tr> <tr> <td>10</td> <td>100 ft./30.5 m</td> </tr> </tbody> </table>	MINIMUM DIELECTRIC CONSTANT	MAXIMUM PROBE LENGTH	1.4	20 ft./6.1 m	4	20 ft./6.1 m	10	100 ft./30.5 m	<p>External Chamber</p>  <table border="1"> <thead> <tr> <th>MINIMUM DIELECTRIC CONSTANT</th> <th>MAXIMUM PROBE LENGTH</th> </tr> </thead> <tbody> <tr> <td>1.7</td> <td>20 ft./6.1 m</td> </tr> <tr> <td>3</td> <td>30 ft./9.1 m</td> </tr> <tr> <td>10</td> <td>50 ft./15.2 m</td> </tr> <tr> <td>35</td> <td>50 ft./15.2 m</td> </tr> </tbody> </table>	MINIMUM DIELECTRIC CONSTANT	MAXIMUM PROBE LENGTH	1.7	20 ft./6.1 m	3	30 ft./9.1 m	10	50 ft./15.2 m	35	50 ft./15.2 m						
MINIMUM DIELECTRIC CONSTANT	MAXIMUM PROBE LENGTH																																										
3	20 ft./6.1 m																																										
4	20 ft./6.1 m																																										
10	100 ft./30.5 m																																										
MINIMUM DIELECTRIC CONSTANT	MAXIMUM PROBE LENGTH																																										
2.5	20 ft./6.1 m																																										
4	20 ft./6.1 m																																										
10	100 ft./30.5 m																																										
MINIMUM DIELECTRIC CONSTANT	MAXIMUM PROBE LENGTH																																										
1.4	20 ft./6.1 m																																										
4	20 ft./6.1 m																																										
10	100 ft./30.5 m																																										
MINIMUM DIELECTRIC CONSTANT	MAXIMUM PROBE LENGTH																																										
1.7	20 ft./6.1 m																																										
3	30 ft./9.1 m																																										
10	50 ft./15.2 m																																										
35	50 ft./15.2 m																																										

1. Accuracy subject to changes in dielectric constant. Ultra-Low Dielectric (ULD) measurement method supports dielectric constants from 1.3 to a maximum of 2.5.

Quotation Request

Material & Connections:

Process Connection: MNPT RF Flange Tri-Clamp Other

Process Connection Description: _____

Probe Material: 316L SS Hast C276 Hast B3 Monel Titanium

Probe Type: Solid Rod Cable (316SS & Monel Only)

Sanitary Rod Specify Finish 180 Grit 240 Grit 240 Grit & EP

(Refer to chart for part numbers)

Centering Disk (Solid Rod): Yes No P/N: _____ If blank, K-TEK will choose.

Centering Weight (Cables): Yes No P/N: _____ If blank, K-TEK will choose.

Housing & Electronics Options:

Aluminum Dual Compartment Housing (standard) 316L SS Dual Compartment Housing Window Cover

HART MODBUS Foundation Fieldbus

Vessel / Application Details:

specify by circling

Total Insertion Length (Bottom of process fitting to end of probe): _____ in / ft / cm / m Other: _____

Standard Lengths for field modification to final length: _____

Custom Lengths for final length by K-TEK _____

Mounting:

Directly on roof of tank Mounted on Nozzle: nozzle height: _____ diameter: _____

In existing stilling well - describe: _____

In new stilling well - describe: _____

In external chamber - describe: _____

Stilling well or external chamber to be supplied with transmitter: Yes No

Approval Required:

FM Factory Mutual

XP-IS / I / 1 / ABCD / T6 Ta = 77°C
DIP / II, III / 1 / EFG / T6 Ta = 77°C
IS / I / 1 / ABCD / T4 Ta = 77°C - ELE1034
NI / I / 2 / ABCD / T4 Ta = 77°C
S / II, III / 2 / FG / T4 Ta = 77°C
ANI / I / 2 / ABCD / T4 - ELE1034
Type 4X

GOST - Russian

Flameproof: 1Exd[ia]IIBT6
Intrinsically Safe: 0ExialIBT6
Ingress Protection: IP67

Canadian Standards Association

XP CL 1, DIV 1, GP ABCD; CL 2, DIV 1, GP EFG; CL 3 - T6
CL 1, DIV 2, GP ABCD; CL 2, DIV 2, GP EFG - T5
IS CL 1, DIV 1, GP CD; CL 2, DIV 1, GP EFG - T4
- when installed per ELE1034
Type 4X

Completed by K-TEK:

Quotation # _____ By: _____ Date: _____

Qty: _____ Part #: _____ Price: \$ _____

Options: _____

Note: All prices USD, EX-Works packed for shipping, FOB Factory, standard shipping 5 weeks ARO.

Additional notes or comments: _____